



DGM5107T



5MP



H.265



Starlight



DWDR



PoE



Line in / out



External I/O



MicroSD Card Recording



5MP H.265 IR Bullet IP Camera

FEATURES

- **Starlight visibility** to offer clear & color images even at night
- MicroSD card support (up to 128GB) for **video storage**
- **ONVIF** (**ONVIFS**) standard supported to simplify system integration
- **POE (Power-over-Ethernet)** support to eliminate the use of power cables and reduce installation costs
- **Line in / out** jacks available for audio transmission
- **External Alarm I/O device** connection
- IR effective range **up to 25 meters** for night surveillance
- **DWDR** to increase image recognizability in overexposure and dark areas
- **Remote Surveillance**
 - **Fully compatible** with **Internet Explorer 6** and above on Windows operating system

DIMENSIONS

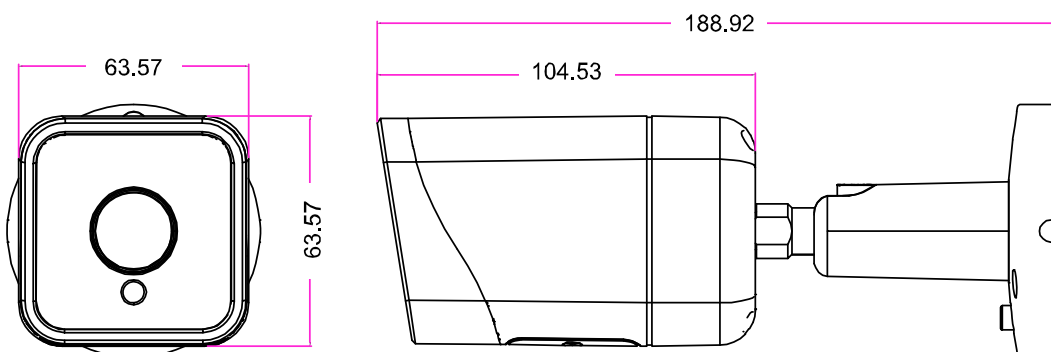

Dimensional tolerance: ± 5mm



○ SPECIFICATIONS

■ Device

Image Sensor	1/2.9" CMOS image sensor
Max. Resolution	2592 x 1944 (5MP)
Lens	f2.8mm / F1.6
Viewing Angle	106.8° (Horizontal) / 68.8° (Vertical) / 134.2° (Diagonal)
Min Illumination	0.01 Lux / F1.6, 0 Lux (IR LED ON)
Shutter Speed	AES
IR LED	2 units
IR Effective Distance**	Up to 25 meters
Day / Night	YES
WDR Mode	DWDR
RTC (real-time clock)	NTP / Manual
Micro SD Card Slot	YES (up to 128GB)

■ Video

Compression	H.265 / H.264 / MJPEG
Video Resolution	2592 x 1944 / 2560 x 1440 / 2048 x 1536 / 1080P / 720P / D1 / VGA / 640 x 360 / CIF
Frame Rate	25 IPS @ 2592 x 1922, 2560 x 1440 & 2048 x 1536 30 IPS @ 1920 x 1080, 1280 x 720, 640 x 480 & 320 x 240
Video Profile	High profile / Main profile / Baseline
Multiple Video Streaming	2 streams
S/N Ratio	More than 52dB (AGC off)
Bitrate Control	CBR / VBR
Image Mode	Normal / Super Starlight / Forced Frame Rate
Image Enhancement	WDR (Level 0 ~ 255) / DWDR / BLC / HLC / 2D DNR / 3D DNR
Day / Night Switch	Auto / Schedule / Manual
Forced Anti-flicker	YES
Defog	YES
White Balance	AWB
Image Orientation	Flip / Mirror
Privacy Mask	4 customized areas
Text Overlay	YES
OSD Title	Location / font size / text configurable; English & Chinese characters supported

■ Audio

Line in	YES
Line out	YES
Encoding	G711 / G711A / AAC
Audio Adjustment	Input & Output

■ Alarm & Event

Alarm-in	YES
Alarm-out	YES
Detection Mode	Human (Day & Night) / Motion
Detection Schedule	YES
Motion Detection Area	1x1, 2x2, 3x3, 3x4, 4x4, 8x8, 16x16, 22x18
Human Detection Alert	Audio alert with customized mp3 audio file(s)

*The specifications are subject to change without notice.



● SPECIFICATIONS (CONTINUED)

■ Storage	
On-Board Storage	Built-in memory card slot, supports microSD / SDHC / SDXC card up to 128GB
Overwrite	YES
Maximum Recoding Time / per File	2, 5, 10, 20 & 30 minutes configurable
Recording Schedule	YES
■ Network	
LAN Port	RJ45 connector x 1
LAN Speed	10/100 Based-T Ethernet
Supported Protocols	TCP/IP, ICMP, HTTP, DHCP, DNS, RTP, RTSP, NTP, IPv4, IPv6, HTML5, ONVIF
ONVIF Compatible	YES (Profile S)
Number of Online Users	6
Security	(1) Up to 10 user accounts with different access levels and passwords (2) IP address filtering (3) Digest authentication
Remote Access	Internet Explorer 6 and above
■ General	
Web Interface Language	English, Korea, Traditional Chinese, Simplified Chinese, Turkish, Italian, German, Russian & Croatian
Operating Temperature	-30°C ~ 50°C
Operating Humidity	30% ~ 90%
POE	YES (IEEE 802.3af)
Power Source (±10%)	PoE (IEEE 802.3af) / DC12V
Power Consumption (±10%)	1.4W Max.
Net Weight (kg)	0.41
Certification	CE / FCC
Casing	IP67
Minimum Web Browsing Requirements	<ul style="list-style-type: none"> • Intel core i3 or higher, or equivalent AMD • 2GB RAM • AGP graphics card, Direct Draw, 32MB RAM • Windows 10, Windows 8, Windows 7, DirectX 9.0 or later • Internet Explorer 6 or above (Windows Edge not supported)

*The specifications are subject to change without notice.